

Bingo Evolution T1 - La poussette confort évolutive

Informations générales :

Prix **Février 2025** en € hors TVA (5,5%) - franco de port

Ces prix peuvent être modifiés sans préavis - Garantie 2 ans

Profondeur d'assise 16-34 cm	Largeur d'assise 18-30 cm	Hauteur dossier 45-63 cm
Inclinaison dossier 90°-160°	Longueur mollet 16-37 cm	Coussin d'assises
Roulettes anti-basculées	Charge maximale 50 kg	Support repose pieds 90°
Anti-bascule	Sac fourre tout léger capacité 3kg	



Coordonnées :

Date essai:

Nom : _____

Adresse : _____

Tel : _____

CP : _____ Ville : _____

Mail : _____

Couleurs

Couleur châssis : Gris métal (002) Noir mat (032)

Couleur accessoires: Noir (346) (les pelotes latérales, cales cuisses et repose tête sont de la couleur des coussins)

Couleur coussins: Noir (346)

Rose pastel (347)

Turquoise pastel (349)

Gris pastel (348)

Couleur plaque (3231-9500): idem coussin idem châssis (photo 41)

N° article		Désignation		Prix	Photo	Code LPPR	Remb.
Châssis et assises							
3232-1000	<input type="checkbox"/>	Châssis T.1 roues (avant) pivotantes + Assise T.1	set	3 123			Si < 16 ans : 9277499 : 962,20€ Si ≥16 ans : 9277447 : 403,50€
3232-2000							
3232-1030	<input type="checkbox"/>	Châssis Cross T.1 roues (avant) pivotantes + Assise T.1 roues de 16 pouces, freins tambour inclus	set	3 578			Si < 16 ans : 9277499 : 962,20€ Si ≥16 ans : 9277447 : 403,50€
3232-2000							
3232-1000	<input type="checkbox"/>	Châssis T.1 roues (avant) pivotantes	pièce	1 525		9277364	263,83€
3232-1030	<input type="checkbox"/>	Châssis Cross T.1 roues (avant) pivotantes	pièce	1 980		9277364	263,83€
SA-0298-MP	<input type="checkbox"/>	axe arrière renforcé (10 kg en + pour accessoires médicaux)	set	249	53		
3232-9401	<input checked="" type="checkbox"/>	sac fourre-tout léger capacité 3 kg	pièce	Inclus	48		
3231-7300	<input type="checkbox"/>	sécurité de transport	set	250	50		
Roues							
1219-0004S	<input type="checkbox"/>	pneus gonflables jante noir	paire	inclus	43		
1229-0004S	<input type="checkbox"/>	pneus pleins PU mousse jante noir	paire	inclus	45		
1229-0009	<input checked="" type="checkbox"/>	pneus pleins PU mousse jante noir	paire	inclus	46		
1219-0030	<input type="checkbox"/>	pneus gonflables frein tambour (2 poignées - jante noir)	paire	405	44	9385036	28,71€
1229-0030	<input type="checkbox"/>	pneus pleins PU mousse frein tambour (2 poignées - jante noir)	paire	405	47	9385036	28,71€
3202-7100	<input type="checkbox"/>	arrêt roues pivotantes	paire	138	38		
Suspensions							
3231-1301	<input checked="" type="checkbox"/>	sans suspension	paire	inclus			
3231-7400	<input type="checkbox"/>	suspension réglable 4 positions / Choix suspensions :	paire	290			
1131-9017	<input type="checkbox"/>	suspension 0 - 15kg (couleur coussins <input type="checkbox"/> châssis <input type="checkbox"/>)					
1131-9018	<input type="checkbox"/>	suspension 15 - 25kg (couleur coussins <input type="checkbox"/> châssis <input type="checkbox"/>)					
1131-9019	<input type="checkbox"/>	suspension plus de 25kg (couleur coussins <input type="checkbox"/> châssis <input type="checkbox"/>)					
Accessoires assise							
3232-5100	<input checked="" type="checkbox"/>	coussin d'assise T1	pièce	inclus			
3232-5190	<input type="checkbox"/>	appui mollet avec insert en mousse	pièce	64	4		

Repose pieds							
3232-2500	<input checked="" type="checkbox"/>	Support repose pieds 90°	pièce	inclus	5		
3232-2402	<input type="checkbox"/>	support repose jambes réglable 85°-170° (UL 19cm minimum)	pièce	138	6		
3231-249X	<input checked="" type="checkbox"/>	Palette monobloc avec rebord arrière □ 1=27cm □ 2=29cm □ 3=31cm □ 4=33cm	pièce	inclus	7		
3231-2551	<input type="checkbox"/>	Palette monobloc avec rebord arrière et latéral largeur 30 cm	pièce	14	7		
3240-2950	<input type="checkbox"/>	verrouillage repose pieds	pièce	159	8		
Maintien (cales - ceintures - plots)							
3231-2900	<input checked="" type="checkbox"/>	petites cales-cuisses réglables en largeur et profondeur (largeur min. 20 cm)	paire	inclus	1		
3231-2600	<input type="checkbox"/>	grandes cales-cuisses démontables réglables en largeur et profondeur	paire	138	2		
3231-7600	<input type="checkbox"/>	petite cale tête T.1	set	259	10	9385088	63,47€
3201-7600	<input type="checkbox"/>	grande cale tête T.1	set	294	11	9385088	63,47€
3231-7700	<input type="checkbox"/>	cale thorax T.1 réglable en hauteur (8 X 10 X 2cm)	set	389	13	9385119	34,92€ x2
3233-7700	<input type="checkbox"/>	cale thorax T.2 réglable en hauteur (10 X 12 X 2cm)	set	389		9385119	34,92€ x2
3231-6701	<input type="checkbox"/>	ceinture de hanche 4 points (SB 18-24)	pièce	244	15		
3231-6702	<input type="checkbox"/>	ceinture de hanche 4 points (SB 22-30)	pièce	244			
3201-6100	<input type="checkbox"/>	ceinture ventrale	pièce	112	14		
3201-6200	<input type="checkbox"/>	ceinture 5 points	pièce	186	16	9385148	96,22€
3201-6300	<input type="checkbox"/>	sangles pieds	paire	50	17		
3201-6400	<input type="checkbox"/>	sangles chevilles T.1	paire	217	18		
3231-5300	<input type="checkbox"/>	ceinture d'abduction T.1	pièce	180	19	9385065	105,53€
3201-5800	<input type="checkbox"/>	veste de maintien T.0	pièce	193	20	9385148	96,22€
3201-5400	<input type="checkbox"/>	veste de maintien T.1	pièce	193		9385148	96,22€
3201-5500	<input type="checkbox"/>	veste de maintien T.2	pièce	193		9385148	96,22€
3201-5600	<input type="checkbox"/>	harnais poitrine T.1	pièce	178	21	9385148	96,22€
3201-5700	<input type="checkbox"/>	harnais poitrine T.2	pièce	178		9385148	96,22€
3231-7800	<input type="checkbox"/>	plot d'abduction T.1 escamotable	pièce	272	22	9385065	105,53€
3231-7801	<input type="checkbox"/>	plot d'abduction T.1 fixe	pièce	153	23	9385065	105,53€
3231-7900	<input type="checkbox"/>	plot d'abduction T.2 escamotable	pièce	272		9385065	105,53€
3231-7901	<input type="checkbox"/>	plot d'abduction T.2 fixe	pièce	153		9385065	105,53€
SA-0311-MP	<input type="checkbox"/>	réglage en profondeur (40mm) plot d'abduction	pièce	61			
Accessoires							
3232-2205	<input type="checkbox"/>	Kit de fixation accessoire (obligatoire pour table et/ou barre de protection)	pièce	61			
3231-8102	<input type="checkbox"/>	barre de protection avec rembourrage T.1	pièce	113	25		
3231-8400	<input type="checkbox"/>	table thérapeutique transparente T.1 (*1,*2)	pièce	489	26	9385071	76,82€
3231-8402	<input type="checkbox"/>	table thérapeutique transparente T.1 réglable en hauteur (*1)	pièce	564	27	9385071	76,82€
3231-8401	<input type="checkbox"/>	table thérapeutique grise T.1 (*1,*2)	pièce	348		9385071	76,82€
3231-8403	<input type="checkbox"/>	table thérapeutique grise T.1 réglable en hauteur (*1)	pièce	423		9385071	76,82€
		<i>*1 uniquement assise sens de la marche *2 pas avec grandes cales-cuisses</i>					
3201-8300	<input type="checkbox"/>	sac hiver T.1 (*3)	pièce	360	28		
3201-8400	<input type="checkbox"/>	sac hiver T.2 (*3)	pièce	379			
7000-0018	<input type="checkbox"/>	insert peau de mouton T.1 (*3)	pièce	275	29		
7000-0019	<input type="checkbox"/>	insert peau de mouton T.2 (*3)	pièce	302			
		<i>*3 si plot d'abduction, uniquement compatible avec plot amovible</i>					
3201-9300	<input type="checkbox"/>	capote pluie avec protection	set	328	31		
7000-0010	<input type="checkbox"/>	buggy board	set	186	51		
7000-0202	<input type="checkbox"/>	sac accessoires + coussin à langer (noir)	set	227	52		

ACCESSOIRES BINGO EVOLUTION

01



02



04



05



06



07



08



10



11



13

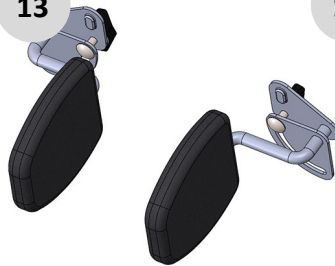

14



15

16



17



18



19

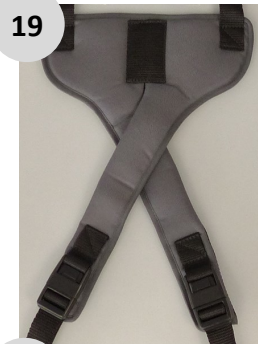

20



21



22

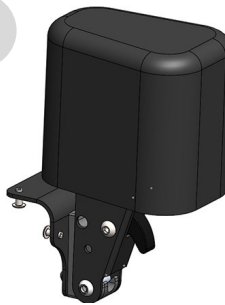

23



24

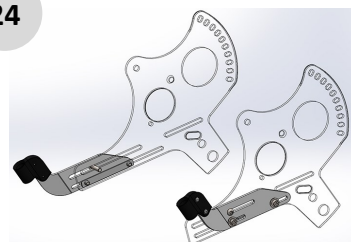

25



26

OU

27

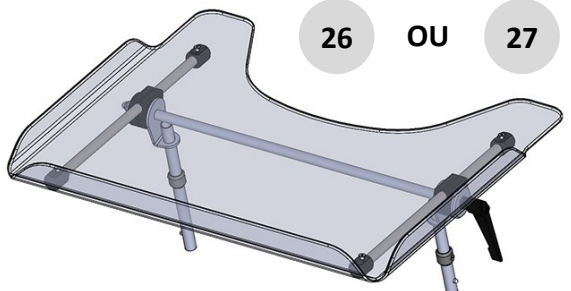

ACCESSOIRES BINGO EVOLUTION



ACCESSOIRES BINGO EVOLUTION

48



49



50



51



52



53

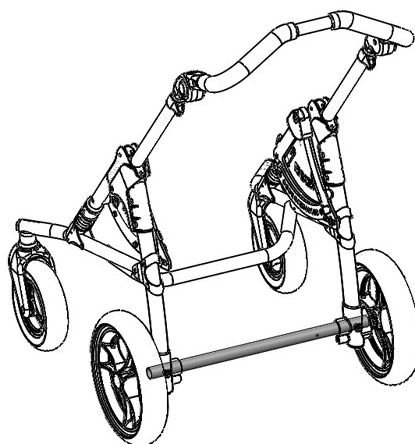

I- COULEUR DU CHÂSSIS

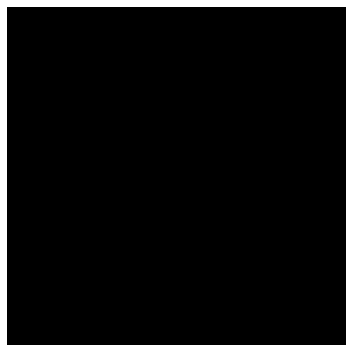

Noir mat
(032)



Gris métallisé
(002)



Une seule couleur de
châssis au choix

Ila- COULEUR DU COUSSIN UNICOLORE



Rose pastel
(347)

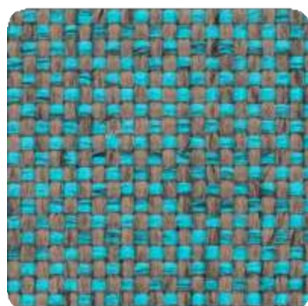

Turquoise pastel
(349)

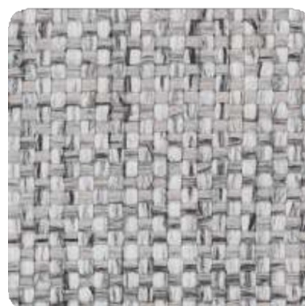

Gris pastel
(348)



Noir

DIFFÉRENTES VARIANTES CHÂSSIS NOIR



DIFFÉRENTES VARIANTES CHÂSSIS GRIS



IIB- COULEUR DU COUSSIN BICOLORE BINGO EVOLUTION



III- COULEUR DE LA PLAQUE DE CÔTÉ

BINGO EVOLUTION

Couleur châssis Couleur coussin—unicolore	Noir mat (032)	Gris métallisé (002)
Rose pastel (347)	Plaque rose ou noire	Plaque rose ou grise
Turquoise pastel (349)	Plaque turquoise ou noire	Plaque turquoise ou grise
Gris pastel (348)	Plaque grise ou noire	Plaque grise
Noir (346)	Plaque noire	Plaque noire ou grise
Couleur coussin bicolore		
Rose pastel / Noir	Plaque rose ou noire	Plaque rose ou grise
Turquoise pastel / Noir	Plaque turquoise ou noire	Plaque turquoise ou grise
Gris pastel / Noir	Plaque grise ou noire	Plaque grise

IV- COULEUR DES RESSORTS

BINGO EVOLUTION

Couleur châssis Couleur coussin—unicolore	Noir mat (032)	Gris métallisé (002)
Rose pastel (347)	Ressort rose ou noir	Ressort rose ou gris
Turquoise pastel (349)	Ressort turquoise ou noir	Ressort turquoise ou gris
Gris pastel (348)	Ressort gris ou noir	Ressort gris
Noir (346)	Ressort noir	Ressort noir ou gris
Couleur coussin bicolore		
Rose pastel / Noir	Ressort rose ou noir	Ressort rose ou gris
Turquoise pastel / Noir	Ressort turquoise ou noir	Ressort turquoise ou gris
Gris pastel / Noir	Ressort gris ou noir	Ressort gris



Rose pastel



Turquoise pastel



Gris pastel



Noir